



**1000W**



**USER  
MANUAL**  
DE HPS/MH REMOTE BALLAST  
MODEL 1000W  
120V/240V, 277V



IL-RMDE1K-120  
IL-RMDE1K-277

877-540-5588  
iluminarlighting.com  
sales@iluminarlighting.com

**THANK YOU** for purchasing an **ILUMINAR Lighting Remote Ballast**. We strive to deliver the best customer service alongside world-class products and we go above and beyond to make sure you are beyond satisfied with your purchase. The following is a general set of warnings and basic guidelines for the ILUMINAR remote ballasts. Always have an expert install your product(s) when possible.

**KEEP ORIGINAL PACKAGING**

In the event of a return, products will need to be in the original ILUMINAR packaging to avoid product damage during shipping. Any damage to products not in their original packaging will not be covered under Warranty. To read more about our product warranty, visit [www.iluminarlighting.com/warranty](http://www.iluminarlighting.com/warranty).

**SAFETY 1ST**

**FAILURE TO OBSERVE THE FOLLOWING WARNINGS COULD RESULT IN ELECTRICAL SHOCK AND SERIOUS INJURY.** Additionally, failure to follow these safety warnings can/will result in a void all warranties as well as any manufacturer liability.

Please read carefully prior to beginning installation.

**WARNINGS**

- ❗ This ballast is compatible only with the ILUMINAR Lighting fixtures. Do not connect any other device to the Control Port. Any attempt to connect it to an incompatible fixture may result in damage to the ballast and will void the warranty.
- ❗ This ballast is intended for indoor and greenhouse applications only. Position it in an area away from excessive heat or contact with liquids.
- ❗ Make sure the power cord and lamp cord are correctly connected.
- ❗ For remote operations, use this ballast with a maximum power cable of 15 feet (240v Nema provided).
- ❗ Lamps with built-in igniters will not work with this ballast. Not for use with external igniters.
- ❗ Disconnect the ballast from the power supply prior moving the unit or performing any maintenance or lamp changes.
- ❗ DO NOT open the ballast case, it will void the warranty.
- ❗ DO NOT support the ballast by power cord(s) and/or lamp cord(s). These cords/connections are not designed to bear weight.
- ❗ DO NOT make contact with the interior of the socket while power is on.
- ❗ DO NOT plug the system into untested or unidentified voltage other than what is designated on ballast.
- ❗ DO NOT attempt to rewire, alter, modify or reconfigure your system - this will void the ILUMINAR warranty and could cause serious safety hazards, or cause bodily injury or death, as this is a high amperage and voltage device.
- ❗ DO NOT submerge in water.
- ❗ DO NOT EVER CONNECT A CMH BALLAST to a Flip Box. It will void the warranty and can cause electrical failure within the CMH Ballast. Flip or Switch Boxes are not recommended for any CMH Units or for any high wattage ballasts.
- ❗ DO NOT plug or unplug the lamp cord while the ballast is connected to power.
- ❗ Keep away from Children. This product contains delicate electronic components. If it is placed near an object that transmits radio signals, it could cause interference (i.e.: mobile devices, walkie talkies, CB radios, remote controls and microwaves). If interference occurs, move such objects away from the appliance.



**1000W**  
DE REMOTE BALLAST

HPS/MH

<b>VOLTAGE:</b>	<b>SKU:</b>
120V/240V	IL-RMDE1K-120
277V	IL-RMDE1K-277



INPUT SPECIFICATIONS

Input Volts	120V	240V	277V
Input Current	9.3A	4.6A	3.80A
Input Power	1,085W	1,055W	1,045W
Output Power	1,000W		
Min Power Factor	0.99		
THD	<10%		
Crest Factor	<1.7		
BTU	200		
Inrush Current	≤ 37.5 Amps		

PROTECTIONS

- End of Lamp Life (EOL) Protection
- Short Circuit Protection
- Open Circuit Protection
- Ignition Failure Protection
- Thermal Protection

OUTPUT SPECIFICATIONS

Rated Voltage	120V/240V	277V
Voltage Range (+/-10%)	108-264V	249V-305V
Dimming Type	600-750-825-1000-1150-EXT	945-1000-EXT
Plug Type	Male NEMA 6-15	Male NEMA L7-15 Twist Lock
Frequency	50/60Hz	
Operational Frequency	100-120Hz	
Operation Temp	0 - 35°C / 32-95°F	
Relative Humidity	85%	
Max. Humidity	95%	
Remote Mounting	5m/16ft	
Ignition Voltage	5kV	

PHYSICAL SPECIFICATIONS

Case Length	275mm	10.83"
Case Width	178mm	7.01"
Height	113mm	4.45"
Weight	3.5kg	7.71lb

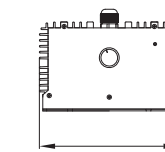

178mm / 7.01"

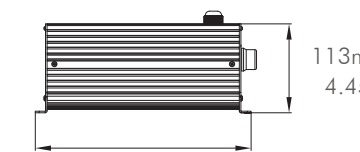

275mm / 10.83"

[iluminarlighting.com](http://iluminarlighting.com)  
Toll Free: 1-877-540-5588



© Copyright 2021 ILUMINAR Lighting  
Subject to change without notice.

**INSTALLATION  
PROCEDURE**

**PLEASE READ CAREFULLY BEFORE INSTALLATION**







When possible, have a licensed electrician or electrical expert install all fixtures or aid in the electrical layout plans and/or diagrams prior to installation.

Check the electrical panel to ensure proper voltage is available for the number of fixtures installed. Panels should only support a total voltage of 80 of its capacity. ie 100 amp panel should never exceed 80 amps. For proper lamp break-in, we recommend that you run the remote ballast and lamp at 100% power for at least 100 straight hours after initial startup. This will improve lamp life and performance.

1. Find a suitable location for the ballast with sufficient cooling and away from any heat source.
2. Install the lamp firmly into the lamp socket of the reflector and connect the lamp cord to the ballast.
3. Remove the power cord from the box.
4. Plug the power cord into the power source (electrical outlet).
5. Once the lamp has fired, set your desired dimming ratio. Please note that the ballast dims or raises output gradually to protect the lamp, so you might not see an instant increase upon changing your output percentage.

RATED VOLTAGE	120V-240V	277V
VOLTAGE RANGE +/- 10%	108-264V	249-305V
OPERATIONAL FREQUENCY	100 - 120Hz	

**PERFORMANCE  
REQUIREMENTS**

-  RJ14 Controller Connection
-  Wieland Female
-  Wieland Male
-  120V SKU CORD: IL-WLDCRD-120V
-  240V SKU CORD: IL-WLDCRD-240V
-  277V SKU CORD: IL-WLDCRD-277V

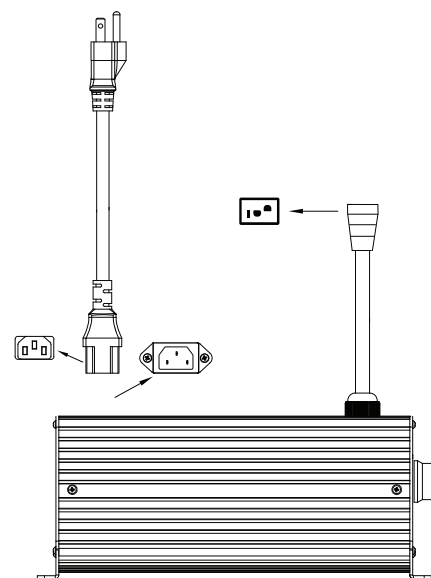

**DIMMING**

- Turn the dimming dial to cycle through the dimming levels.
- If your lamp fails to start immediately, DO NOT cycle the power on and off. This can damage the lamp and ballast.
- If after 30 minutes your lamp is still not lit, shut off power to the ballast, and reconnect.
- This will begin the startup sequence again.
- Until the lamp has achieved at least 100 hours of operation, the lamp should never be turned off prior to running at least 15 minutes. In case this happens, WAIT 1 hour before igniting the lamp again.

**HOT RESTRIKE**

**IT IS VERY IMPORTANT** that the lamp is given adequate time to cool down before it is reignited. Allow a hot lamp to cool for 1 hour before you try to restrike it. Hot re-strikes cause permanent lamp failure and lumen output degradations. The lamp should never be turned off before the lamp reaches full intensity, this may shorten its lifespan.

**MOUNTING  
LOCATION**

**DO NOT** install ballasts in areas of high heat, such as an attic, tent or closed closet. Mount units at least 24-60 inches apart.

**BALLAST  
PROTECTIONS**

1. End of Lamp Life (EOL) Protection
2. Short Circuit Protection
3. Open Circuit Protection
4. Ignition Failure Protection
5. Thermal Protection
6. Suitable for ILUMINAR Touch Controller & HASH Controller

**PHYSICAL  
SPECIFICATIONS**

CASE LENGTH	275mm	10.83"
CASE WIDTH	178mm	7.01"
HEIGHT	113mm	4.45"
WEIGHT	3.5kg	7.71 lbs

**BALLAST CARE**

1. Max. allowable case temperature: 35° C / 95° F
2. Ambient Temperature: 0 - 35°C / 32-95°F
3. Max. Humidity: 95%
4. Ignition Voltage: 5kV

## PROPRIETARY ROLL LOCK SOCKET (ILUMINAR FIXTURES)

ILUMINAR Lighting created the first of its kind, single-handed "Roll-Lock" socket for simple, one-handed lamp installation. We know it can get tricky to load new lamps - it's too easy to drop the lamp and lose that investment. Keep your lamps safe when you install using the Roll Lock socket. The Roll Lock Socket works with all DE Lamps - HPS, MH, and CMH, for all wattage options.

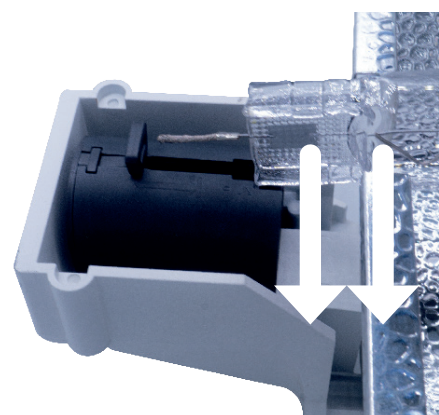
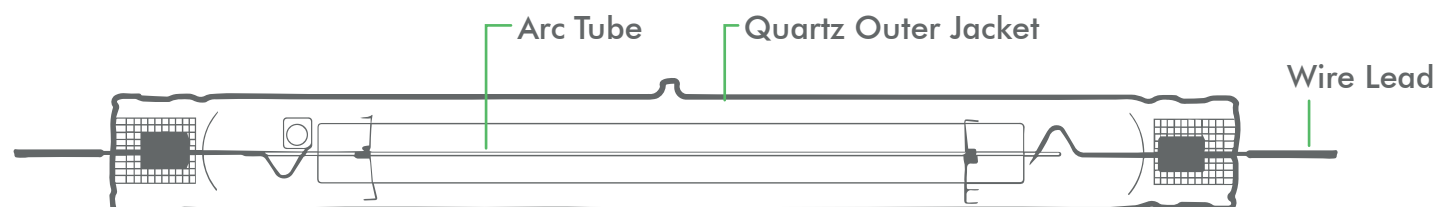

Photo A

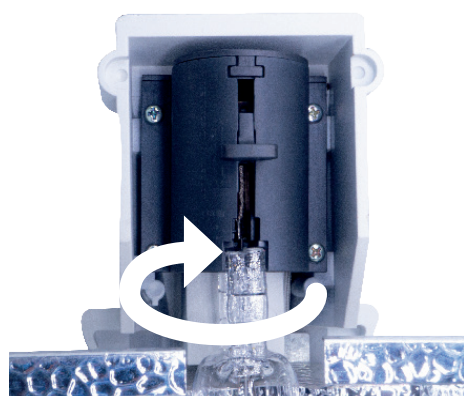

Photo B

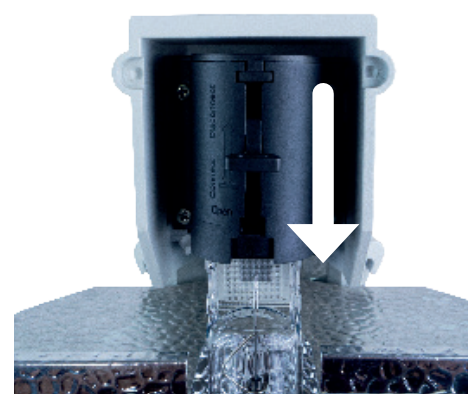

Photo C

### ROLL LOCK SOCKET INSTALLATION

1. Slide both levers away from the lamp to the "Open" position. (Photo A) Each socket applies up to 5mm of lateral pressure to ensure a secure fit.
2. Ensure both wire ends/leads are straight - **DO NOT BEND THE WIRE LEADS!** Ensure the wire leads are **NOT FRAYED OR LOOSE** (if there are frays, twist them back into the wire leads). Small frays of metal can cause the fixture to arc or melt.

**CAUTION: DO NOT HANDLE THE LAMP WITH BARE HANDS**  
The oils from your hands can be dangerous when burning off in the high heat of the lamp.

### ROLL LOCK SOCKET INSTALLATION (CONT.)

3. Using soft gloves to handle the lamp, slide the lamp into the fixture (with metal leads straight) until the lamp is fully seated.
4. Rotate the bulb, itself, to lock it into place (so that it will not move).
5. Slide both socket levers toward the lamp to the "closed" position to add a second lock to fix the lamp into position. If the lamp is seated correctly, both levers should easily slide inward to lock the DE lamp into the socket. It is now ready to use.

**DO NOT** force the levers closed, this can cause damage to both the lamp and the levers. **DO NOT** handle the lamp with bare hands. Always wear surgical or cloth gloves when handling the lamp to minimize fingerprints and oils left on the lamp. If the lamp needs cleaning after installation, use a soft, dry cotton cloth to wipe off fingerprints/skin oils.

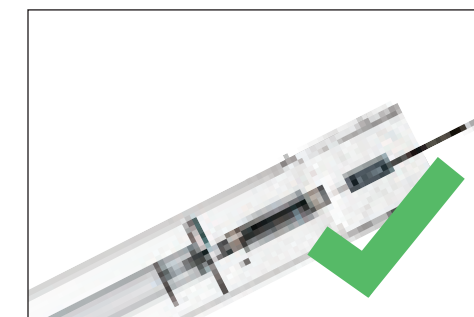
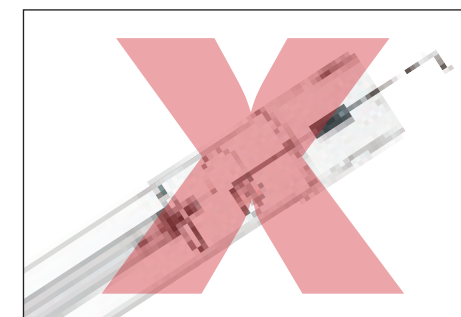
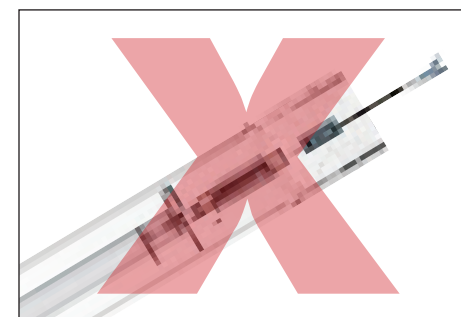

### ROLL LOCK SOCKET UNINSTALL

1. To remove or change the lamp, simply follow the steps above.
2. Slide both socket levers away from the lamp to the "Open" position. (Photo A)
3. **USING SURGICAL OR COTTON GLOVES**, gently rotate the lamp itself to open the Roll Lock Socket.
4. Gently lift the lamp out of the sockets.
5. Rotate the new bulb into place.
6. Slide both socket levers toward the lamp to the "closed" position.

### WATCH ROLL LOCK VIDEO GUIDE



# TROUBLESHOOTING

Follow these common troubleshooting tips:

Possible Cause	Corrective Maintenance
Lamp Loose in Socket	Ensure the lamp is fully inserted into the socket and that it has been properly locked.
Incorrect Voltage	Make sure you're using the correct input voltage with ballast. If using incorrect voltage, disconnect the ballast from the power source immediately.
Defective or Improper Wiring	Examine wiring to ensure it agrees with wiring diagrams on ballast label. Check connections to see that they are secure. If wiring a 240v ballast, DO NOT use a neutral. The correct wiring is two hot wires and a ground.
Poor electrical connections	Check wiring and lamp contact with socket.
Incorrect Lamp	Verify that you're using a correct wattage lamp.
Lamp Damage	Investigate possibility of outer lamp damage. Look for broken tubes or loose metal replace lamp.

## RETURNS

## WARRANTY

Please contact your point of purchase store for returns.

When properly used, this unit will provide you with years of service. It is covered under a 3 year warranty. This warranty will be voided if the unit is misused, abused, opened or altered. Warranty repair or replacement will be at the sole discretion of the manufacturer. Defective units need to be returned to the place of purchase with proof of purchase/receipt.

For more warranty information, visit [iluminarlighting.com/warranty](http://iluminarlighting.com/warranty)

## CERTIFICATIONS



**This guide does not supersede national, state, or local regulations for electrical installations.**