



iLW
LED Lighting Solutions



USER MANUAL

iLW MODEL 40W & 60W



iLW 40W IL-4025FSG-120
iLW 60W IL-6025FSG-120

1-877-540-5588
iluminarlighting.com
sales@iluminarlighting.com



CONTENTS

Pre-Install Information	2
Technical & Physical Specifications.....	3
Hardware & Accessories	4
Hanging Instructions	5-6
Mounting Instructions	7
Additional Accessories.....	8-9
Important Cautions & Warranty	10

Please read this manual thoroughly prior to installing or operating the ILUMINAR iLW.

- Observe all safety precautions (see page 10), seek the services of a qualified electrician, installation professional, or call ILUMINAR Lighting technicians for assistance.
- DO NOT handle or touch the fixture while in use.
- Connect the fixture only to the power sources of the appropriate voltage using the correct AC plug type. Protect power cables from being pinched, walked on, or otherwise damaged. Be especially careful where the power cable enters the power outlet to the unit. Only connect the fixture to an electrical outlet or extension cord of comparable standard and level rating. Connect the fixture ONLY to the power sources of the correct voltage using the plug received.
- The fixture should only be cleaned as directed. Always seek service for your system by qualified service personnel if any of the following occur:
 1. The fixture shows a noticeable change in performance.
 2. The power-supply cord or plug is damaged.
 3. The fixture has been dropped, or the exterior is damaged.



iLW

40W / 60W MODELS

MODEL:	2.5	VOLTAGE:	120-277V
WATTS:	40W	SKU:	IL-4025FSG-120
	60W		IL-6025FSG-120



TECHNICAL SPECS	40W	60W
PPF	100 $\mu\text{mol/s}$	150 $\mu\text{mol/s}$
BTU	136	204
Emitter Type	Multiple Spectrum LED Diodes	
Efficacy	2.5 $\mu\text{mol/J}$	
Minimum Mounting Height	6-12" to top of Canopy	
Emitter Cooling	Passive / Extruded Case	
Waterproof Rating	IP65 for Damp / Wet Conditions	
LED Lifespan (90%)	55,000+ hours	
Power Factor	> 90%	
Ambient Temperature	0 - 35°C / 32-95°F	
Color Temperature	4000k	
Relative Humidity	98%	
Frequency	50 / 60Hz	
THD	< 20%	
Color Rendering Index	88	
Min. Power Factor	0.9	
Crest Factor	0.99	

ILW LED SPECTRUM

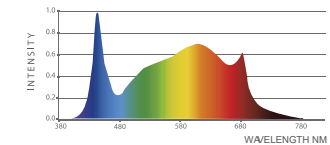

MOUNTING & COVERAGE

ILW 40W & 60W

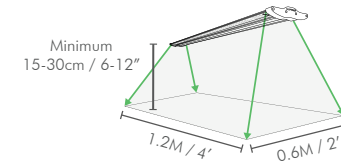

VOLTAGE AND AMPERAGE

	40W			60W	
120V	0.36A	42W	0.53A	62W	
208V	0.20A	41W	0.30A	61W	
240V	0.18A	40W	0.27A	60W	
277V	0.16A	40W	0.24A	61W	

PHYSICAL SPECS

	40W	60W
Height	29mm / 1.14"	29mm / 1.14"
Width	130mm / 5"	130mm / 5"
Length	1200mm / 47.2"	1200mm / 47.2"
Weight	1kg / 2.2 lbs	1kg / 2.2 lbs



iLW 40W & 60W

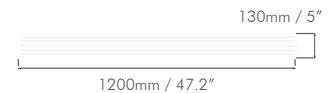

HARDWARE AND ACCESSORIES

The iLW LED fixture can be hung from steel cables or can be mounted to a rack.

Before you begin installation, check that you have all the necessary parts to begin.

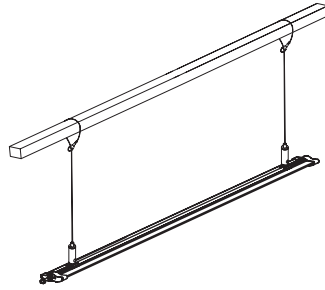

IN THE BOX



1 iLW Fixture



2 Metal Clips for Hanging Cables



2 Screws for Clips & Hanging Cables



2 Steel Hanging Cables with Cylindrical Lock



4 Screws & 4 Anchors

HANGING INSTALLATION

1

Loop the steel cables over the beam, feeding the wire through its loop and letting the cylindrical lock hang.

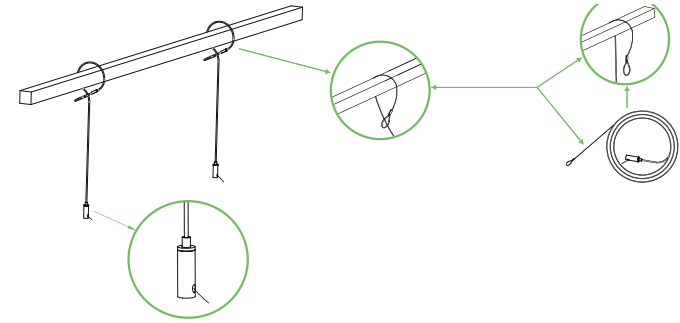

2

Using the provided screw, attach the clip to the steel cable's cylindrical lock.

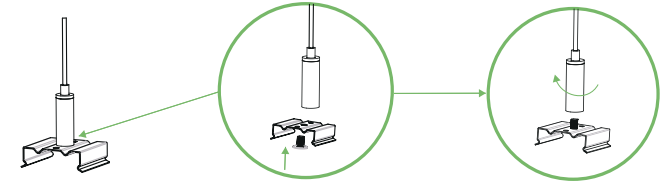

3

Snap the clips onto the light bar's heat sink.

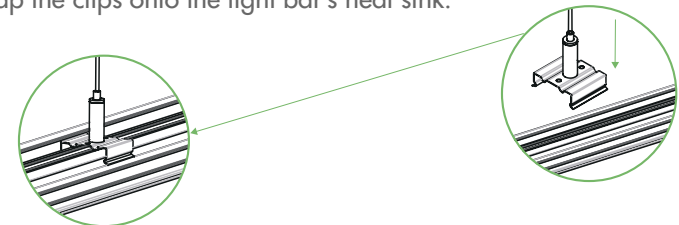

(see next page...)

MOUNTING INSTRUCTIONS

4

Adjust the spacing of the clips as needed.

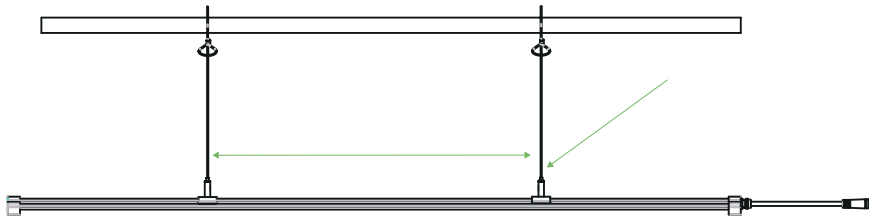

5

Pull the steel cable down through the cylindrical lock to adjust the fixture height.

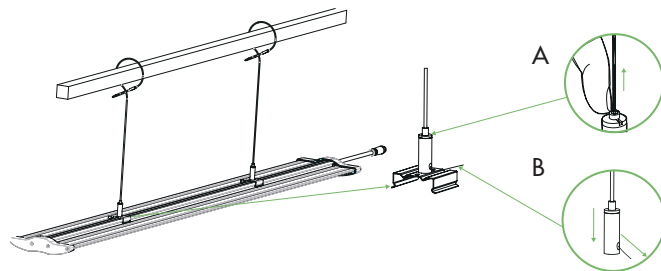

To shorten cable: Press the cable down through the cylindrical lock. (Figure A)
To extend cable: Press metal top down and pull up on cable. (Figure B)

1

Drill 4 holes into an overhead structure or rack. Insert the provided mounting anchors into the holes and screw the metal clips directly into the anchors.

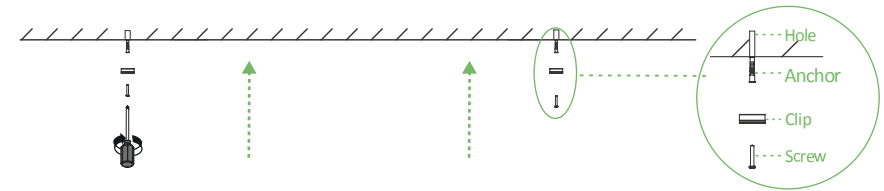

2

Snap the bar into the clips.

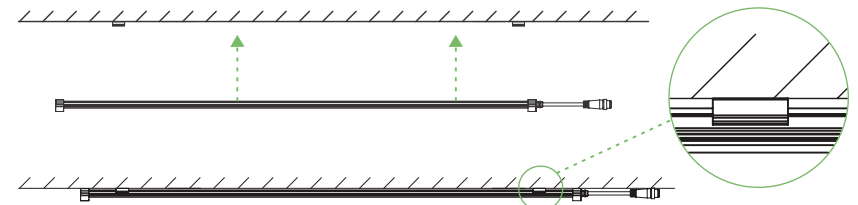

ADDITIONAL ACCESSORIES

iLW Power Hub

If you use more than one iLW in your grow room or clone rack, save space by adding in the iLW Power Hub. The hub comes as a dual-, tri- or quad-connector that will send power to each of your iLW fixtures without the need of additional outlets.

When using the iLW Dual/Tri/Quad Power Hubs for daisy chaining fixtures, the max load at 120V is 400W Power and at 277V is 800W power.

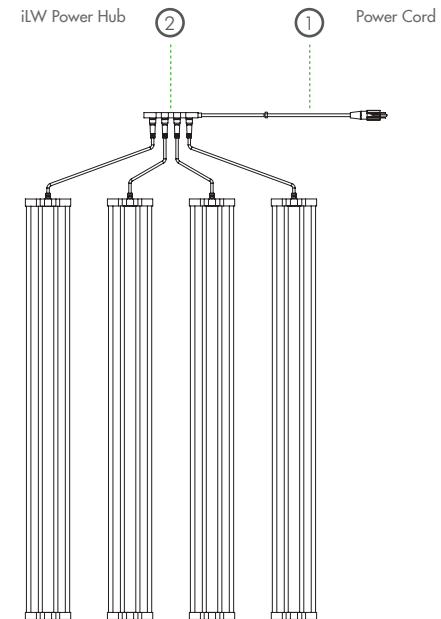

	NAME	VOLTAGE	SKU	DIAGRAM
①	Power Cord iLW and iLBar - 120V	120V	IL-ILWCRD-120	5-15P
	Power Cord iLW and iLBar - 240V	240V	IL-ILWCRD-240	6-15P
	Power Cord iLW and iLBar - 277V	277V	IL-ILWCRD-277	L7-15P
②	iLW and iLBar Quad Connector	N/A	IL-LEDCON-DUAL	
	iLW and iLBar Triple Connector	N/A	IL-LEDCON-TRIP	
	iLW and iLBar Dual Connector	N/A	IL-LEDCON-QUAD	
③	Extension Cord for iLW and iLBar	120V-277V	IL-LEDCON-Extension	

PRECAUTIONS

Please read the following list carefully prior to beginning installation.

1. Leave at least one inch of space between the fixture and the mounting area for maximum performance and lifespan.
2. ALWAYS wear protective eyewear when looking directly at the diodes to prevent eye damage.
3. Only handle, clean or move fixture when it's unplugged and completely cool.
4. Keep the fixture free of dust, debris, and deposits to ensure the maximum potential of the fixture.
5. NEVER use a cloth to clean the diodes. This can scratch the diodes and could potentially break or dislodge them.
6. DO NOT use chemicals to clean the fixture. Use ONLY low pressure air or low pressure water to remove dust and debris.
7. DO NOT exceed 70% max load for breakers due to inrush current in LED fixtures
8. Do NOT use sulfur vaporizers.

5 YEAR WARRANTY GUARANTEE

At ILUMINAR, we stand behind our products and our technology as well as our customers. All ILUMINAR LED fixtures are backed by our 5-Year Guarantee. Please visit our website iluminarlighting.com/warranty for more information.