



Cable **Logic**TM

POWER AND DATA MANUAL

Compatible With:

iLogicPLUS MS, iLogicPLUS FS, iLogic Series, HYPERMOL & HYPERMOL PRO



INDEX

CABLE LOGIC PRODUCTS

POWER AND CONTROL FOR
iLogicPLUS MS, iLogicPLUS FS, iLogic Series, HYPERMOL & HYPERMOL PRO



Click below to jump to product details.

[CONNECTION DIAGRAMS](#)

[MAIN LINE POWER CABLES](#)

[2 MAIN LINE POWER EXTENSION CABLES](#)

[3 JUNCTION MAIN-LINE AC CONNECTORS](#)

[4 SECONDARY POWER AC EXTENSION CABLES](#)

[5 IP67 CONTROL CABLES](#)

SINGLE JOINT CONNECTION

FIXTURE-TO-FIXTURE CONNECTION DIAGRAM

Connect up to 2 fixtures together using the Cable Logic™ Single Joint Connector



Click below to jump to product details.

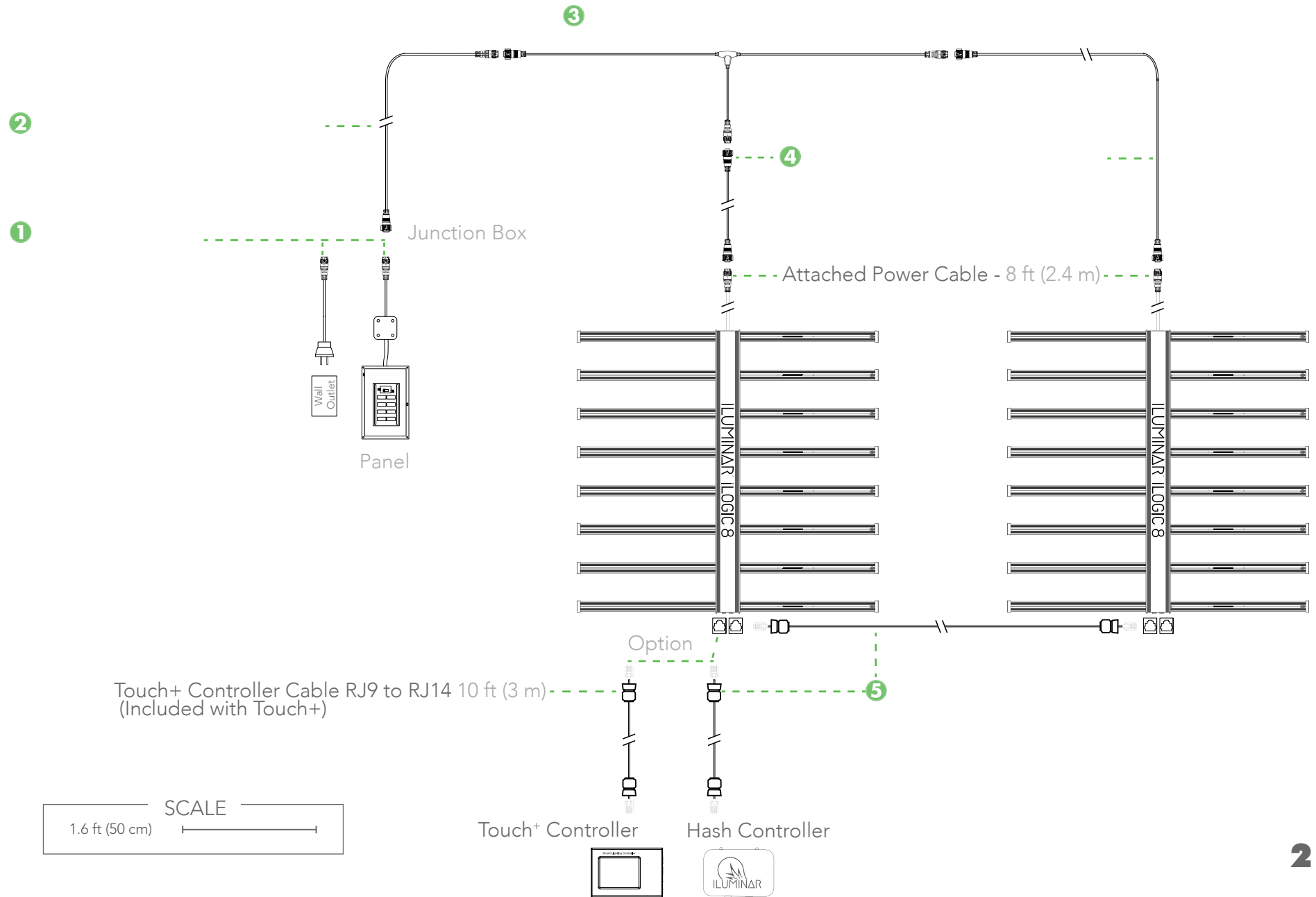

MULTI-JOINT CONNECTOR

CONNECT 3+ FIXTURES

CABLE LOGIC™ MULTI JOINT



Click below to jump to product details.

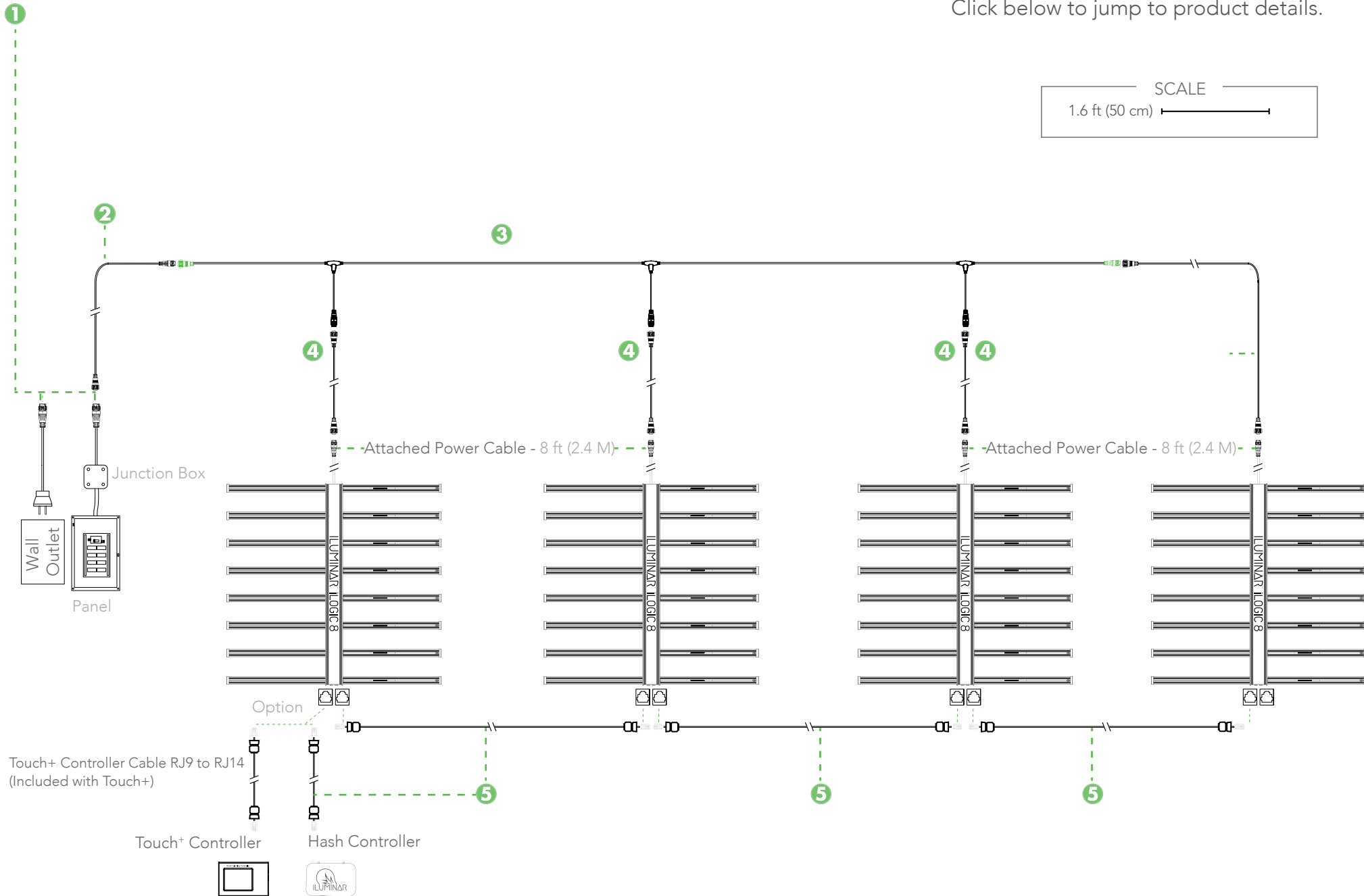
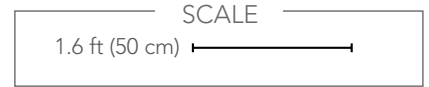

1

1 120V AC Power NEMA 5-15 Plug
SKU: IL-T120

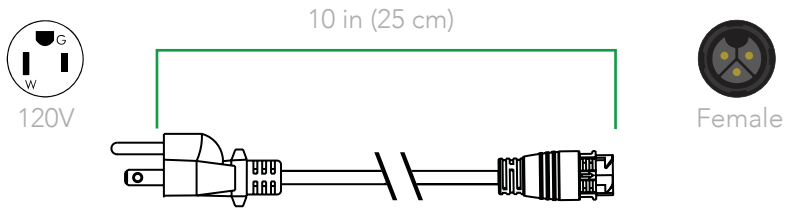

1 240V AC Power NEMA 6-15 Plug
SKU: IL-T240

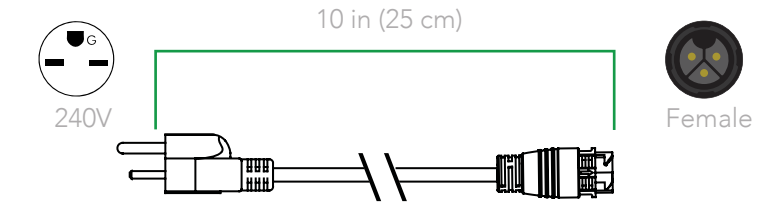

1 277V AC Power NEMA L7-15 Plug
SKU: IL-T277

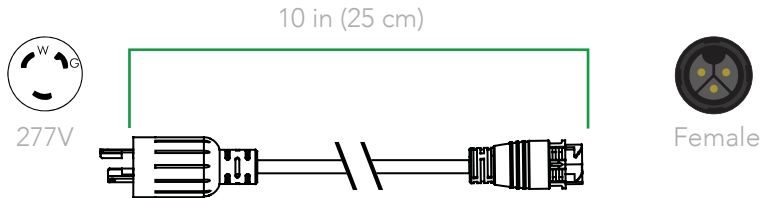

1 347V AC Power NEMA L24-20 Plug
SKU: IL-T347

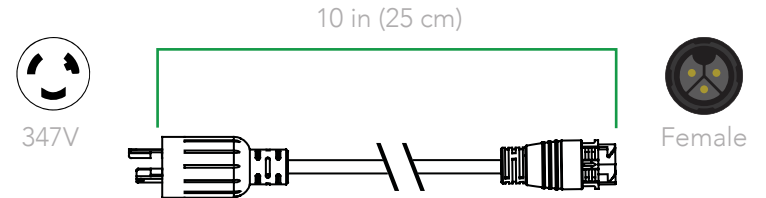

1 Panel Mount 20A - 480 VAC
SKU: IL-PNLM

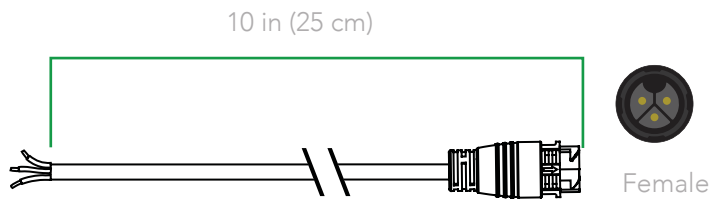

SPECIFICATIONS

Certifications	UL
Flame test	VW-1

2

2 3 ft
SKU: IL-TML3

3 ft (90 cm)

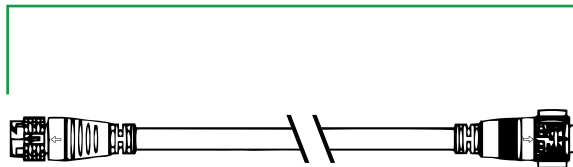

Female

Male

2 6 ft
SKU: IL-TML6

6 ft (1.8 M)

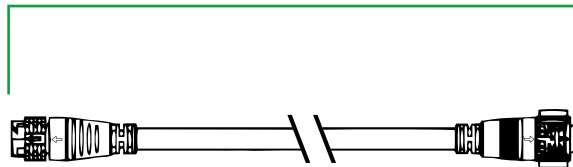

Female

Male

2 15 ft
SKU: IL-TML15

15 ft (4.5 M)

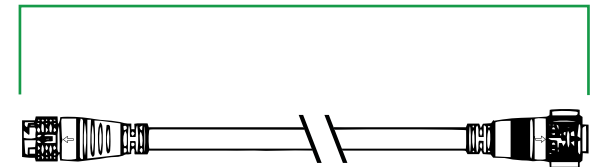

Female

Male

SPECIFICATIONS

Voltage	120V-480V
Certification	UL
Flame test	VW-1



Female



Male

3

JUNCTION MAIN-LINE AC CONNECTORS SINGLE JOINT CONNECTOR, MULTI-JOINT CONNECTOR

3

SINGLE JOINT CONNECTOR

SKU: IL-SJC

SPECIFICATIONS

Voltage	120V-480V
Maximum Quantity of Fixtures	2
Certification	UL
Flame test	VW-1
Length	5 ft (1.5 M)

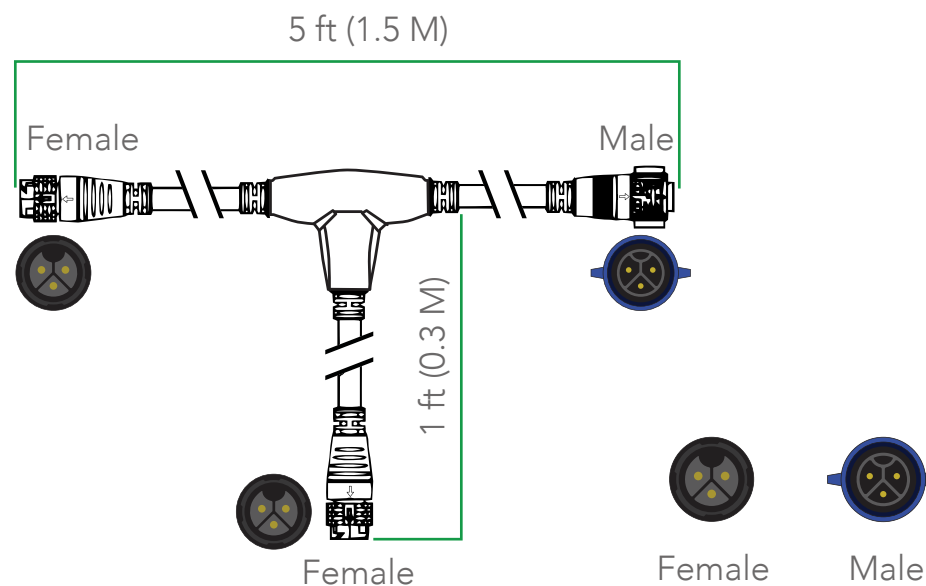

3

MULTI JOINT

SKU: IL-MJC

SPECIFICATIONS

Voltage	120V-480V
Maximum Quantity of Fixtures	4
Certification	UL
Flame test	VW-1
Length	5 ft (1.5 M)

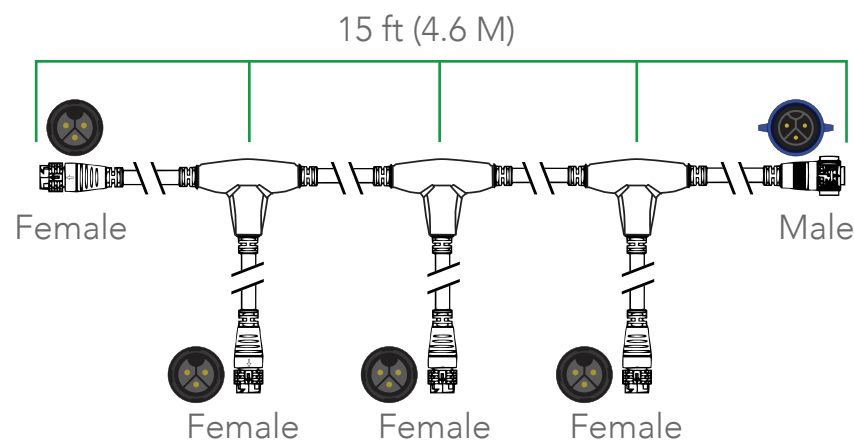

4

4 3 ft
SKU: IL-TS3

3 ft (90 cm)

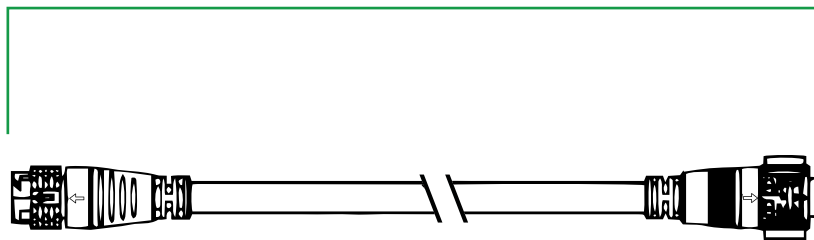

Female

Male

4 6 ft
SKU: IL-TS6

6 ft (1.8 M)

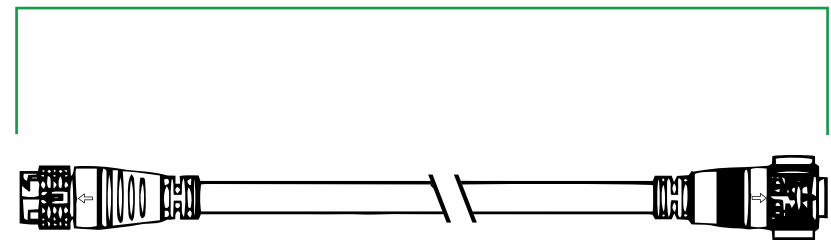

Female

Male

SPECIFICATIONS

Voltage	120V-480V
Certification	UL
Flame test	VW-1



Female



Male

5

Cable Logic™

CONTROL CABLES

RJ14 - RJ14



5 1.3 ft
SKU: IL-D1

1.3 ft (30 cm)

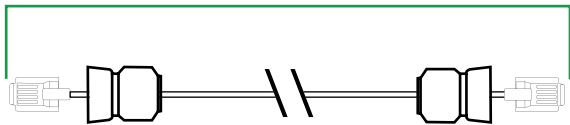

5 3 ft
SKU: IL-D3

3 ft (90 cm)

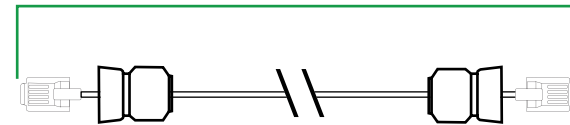

5 6 ft
SKU: IL-D6

6 ft (1.8 M)

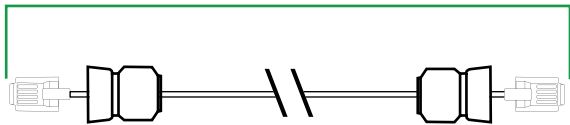

5 10 ft
SKU: IL-D10

10 ft (3 M)

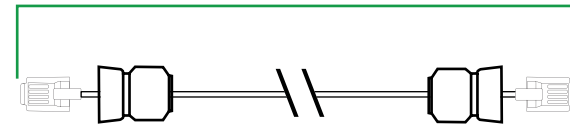

5 20 ft
SKU: IL-D20

20 ft (6 M)

