

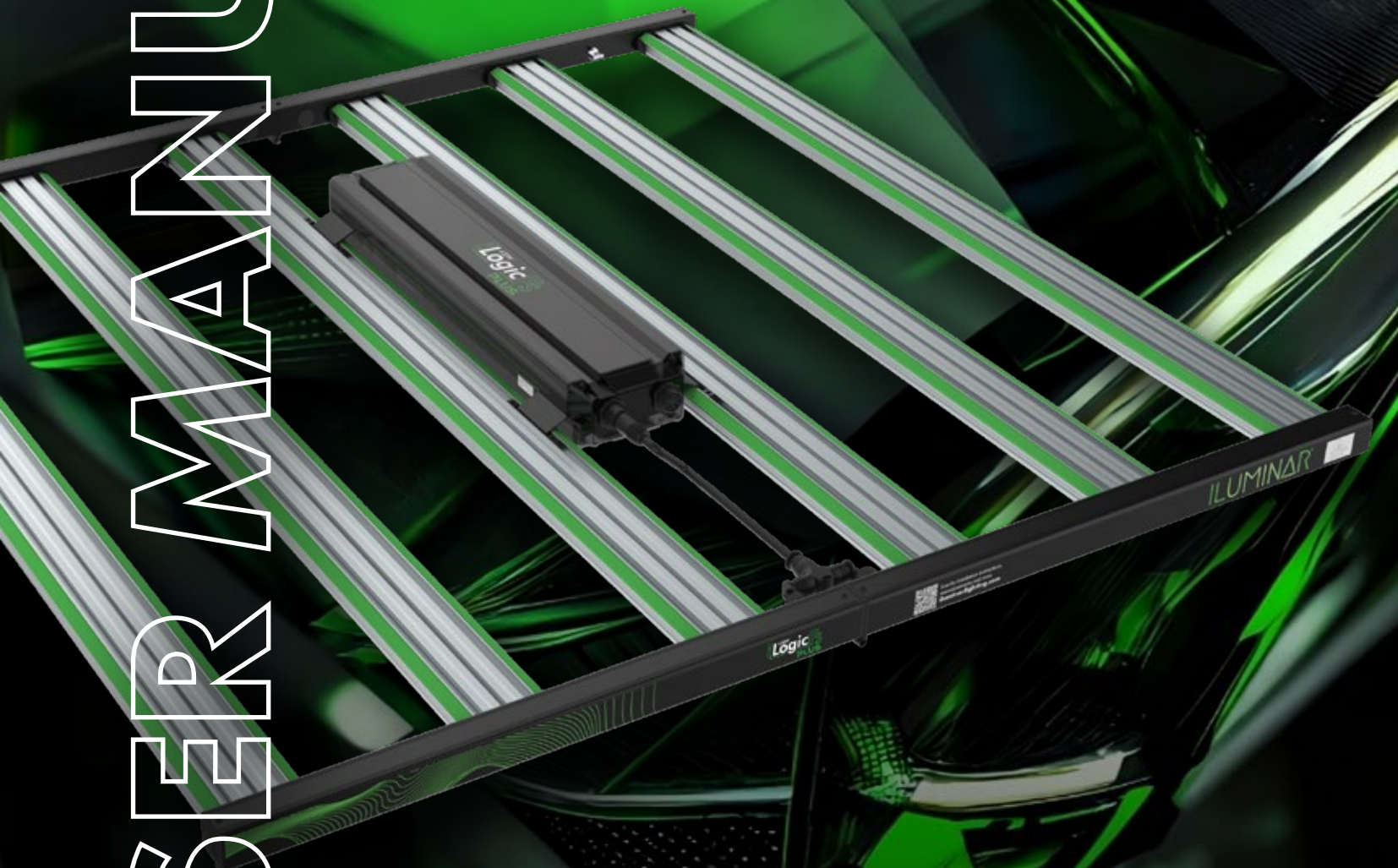

**iLogic<sup>TM</sup> FS PLUS**  
630W

# USER MANUAL



**iLogic<sup>TM</sup> FS Plus**  
**630W** IL-L630FS

# 00 Contents



- 01** Pre-Install Information
- 02** Technical Specification
- 03** Physical Specifications
- 04** Hardware & Accessories
- 05** Hanging Installation
- 06** Rebate Program
- 07** Important Cautions & Warranty



**Please read this manual thoroughly prior to installing or operating the ILUMINAR iLogic™ FS PLUS 630W**

- Observe all safety precautions (see page 11), seek the services of a qualified electrician, installation professional, or call ILUMINAR Lighting technicians for assistance.
- DO NOT handle or touch the fixture while in use.
- Connect the fixture only to the power sources of the appropriate voltage using the correct AC plug type. Protect power cables from being pinched, walked on, or otherwise damaged. Be especially careful where the power cable enters the power outlet to the unit. Only connect the fixture to an electrical outlet or extension cord of comparable standard and level rating. Connect the fixture ONLY to the power sources of the correct voltage using the plug received.
- The fixture should only be cleaned as directed. Always seek service for your system by qualified service personnel if any of the following occur:
  1. The fixture shows a noticeable change in performance.
  2. The powersupply cord or plug is damaged.
  3. The fixture has been dropped, or the exterior is damaged.



## DELIVERY CONTENTS

- 1x 340W LED Fixture
- 1x LED Driver
- 1x Power Cable with Plug Additional
- 1x 3m RS485 Signal Cable
- 2x Adjustable Hanging Kits
- 2x un-adjustable Hanging Kits
- 1x Allen Key



*This commercial fixture **requires a controller to operate**, which must be purchased separately. The fixture's initial default is set to Null/Off. Ensure your Plus Controller is connected and properly configured before use to prevent issues.*





# 02

## Technical Specs

**MODEL:** ILOGIC FS PLUS**WATTS** 630W**VOLTAGE:** 100 - 277V**SKU** IL-L630FS

### TECHNICAL SPECS

Rated Voltage	100 - 277V
Power Consump	630w ± 5%
Power Supply	Sosen LED Drivers
PPF	2099 μmol
Efficacy	3.11 μmol/J
LED Spectrum	Full Spectrum
Min Power Factor - Power Factor	>0.9
THD	<10%
Crest Factor	<10%
BTU	2100
Frequency	60Hz
Dimming	0 -100% dimming via RS485
Ambient Temperature - Working	0°C - 35°C / 32° - 95°F
Relative Humidity	<90%
Color Temperature	4000K
Color Rendering Index	85
Emitting Cooling	Aluminum heatsink
Light Distribution - Beam Angle	120 Degrees
Waterproof Rating	IP65
LED Lifespan	50000 hours
Daisy Chain	Max. 256 LED fixtures for output A and output B individually
Light Source	Samsung LM281B+Pro White LED * 1872 pcs  Honglitrionic SMD3535 660nm Red LED* 168 pcs

### VOLTAGE AND AMPERAGE

Voltage	120V	208V	220V	240V	277V
Amperage	5.25A	3.03A	2.87A	2.63A	2.28A

### PHYSICAL SPECIFICATIONS

Height	75 mm / 2.9"
Weight - N.W./G.W.	11.5kg / 13kg   25.3lbs / 28.6lbs
Package Size	1130*575*85mm / 44.5* 22.6*3.3"

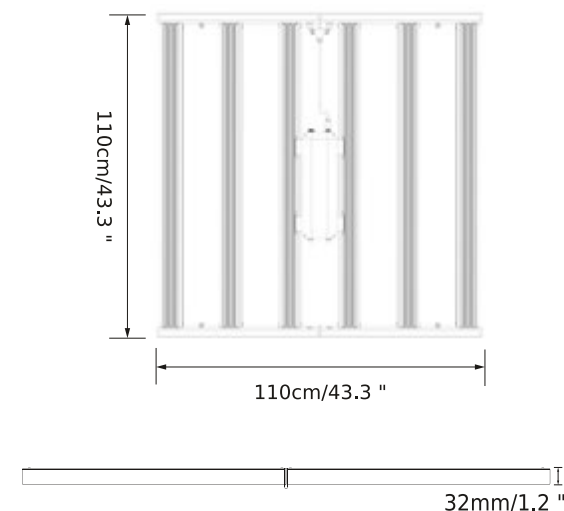

### SPECTRUM

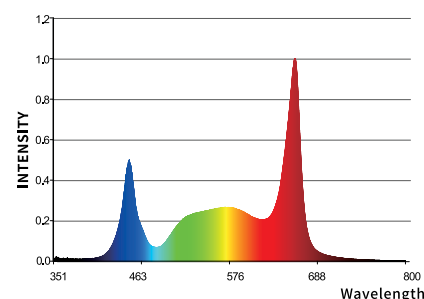

This commercial fixture requires a separately purchased Plus Controller to operate.

**5 YEAR**  
WARRANTY



[www.iluminarlighting.com](http://www.iluminarlighting.com) ☎ 1-877-540-5588 ✉ [sales@iluminarlighting.com](mailto:sales@iluminarlighting.com)

© Copyright 2024 ILUMINAR Lighting. Subject to change without notice.

**PPF MAP**

Height of  
**12" / 30CM PAR** Distribution

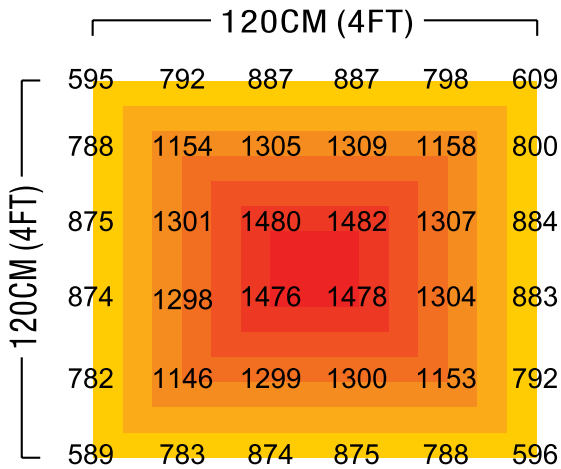

Height of  
**24" / 60CM PAR** Distribution

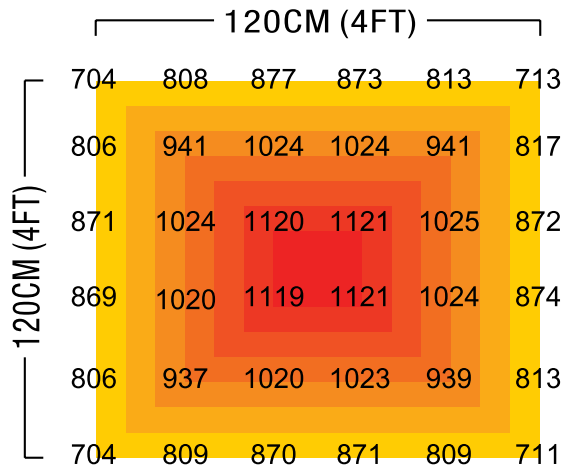

Height of  
**31" / 80CM PAR** Distribution

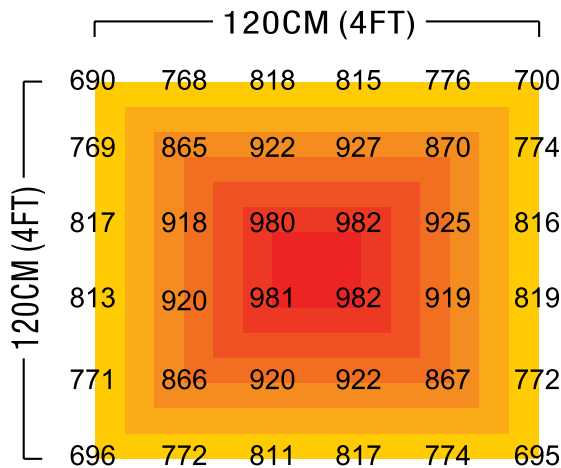

Height of  
**39" / 100CM PAR** Distribution

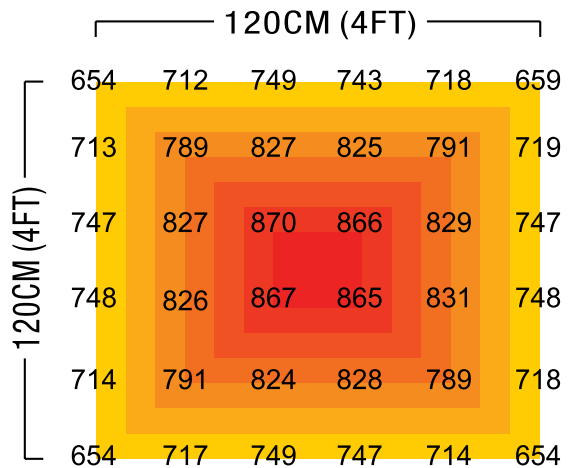

# 03

## Physical Specifications



### MAIN PARTS OF LED FIXTURE:

1 Aluminum Frame

5 Bracket

2 Signal In & Out

6 Driver Box

3 Hanging Ring

7 AC Input

4 Aluminum LED bar

8 DC Output

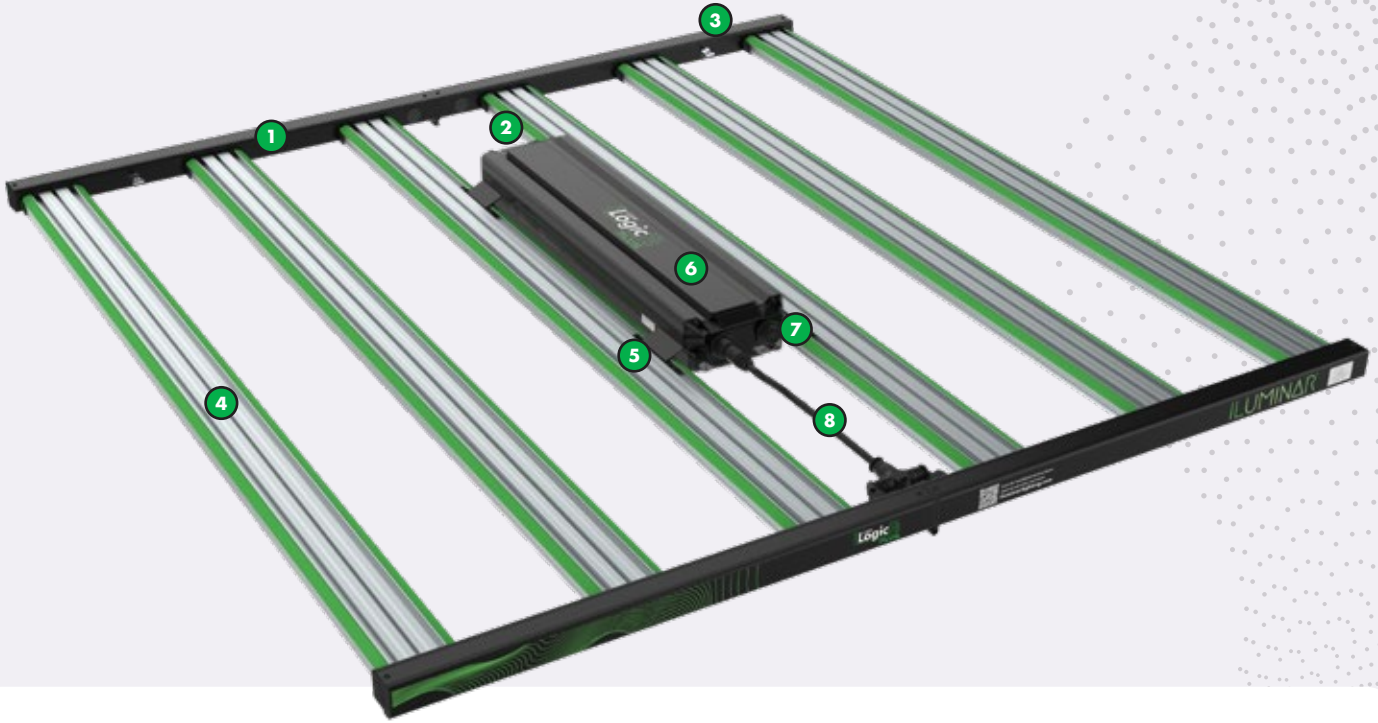

Folding design and compact package:

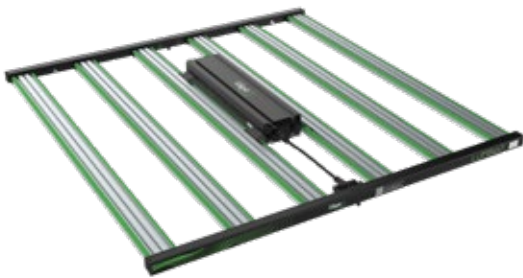

Easy replacement design:

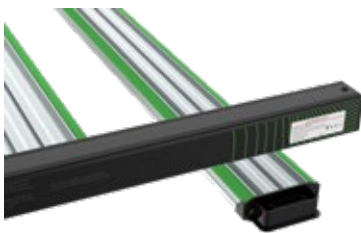

To replace single LED bar



To replace driver box

# 04

## Hardware & Accessories



The **iLogic™ FS PLUS 630W** can be hung from rope ratchets or can be mounted to a rack.

Before you begin installation, check that you have all the necessary parts to begin.

# iLogic PLUS



### IN THE BOX

1 iLogic™ FS PLUS 630W



1 LED Driver

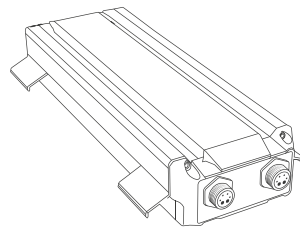

1 Power Cable

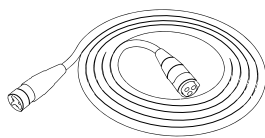

1 Signal Cable

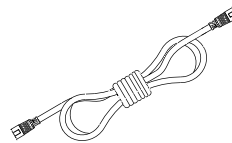

2 Adjustable Hanging Kits

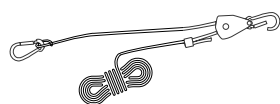

2 Un-adjustable Hanging Kits



# 04

## Hardware & Accessories

### GET THE MOST OUT OF YOUR FIXTURE

The iLogic Plus is a cutting-edge smart fixture that remembers the last setting programmed with your controller, ensuring consistent performance and eliminating the risk of plant hermaphroditism.



VOLTAGE: 110 - 277V

SKU: IL-PLUS-CTRL



VOLTAGE: 110 - 277V

SKU: IL-PLUS-CTRL



This commercial fixture requires a separately purchased Plus Controller to operate.



# 05

## Hanging Instalation

1. To suspend mount, attach the 4 rope ratchets that come packaged with this fixture to the LED.
2. Lift the LED and attach the carabiners to pre-installed hooks from ceiling or mounting beam. The ratchets should be installed closest to the LED (and not the ceiling).

**A:** Remove slack to raise fixture.

**B:** Give slack to lower fixture.

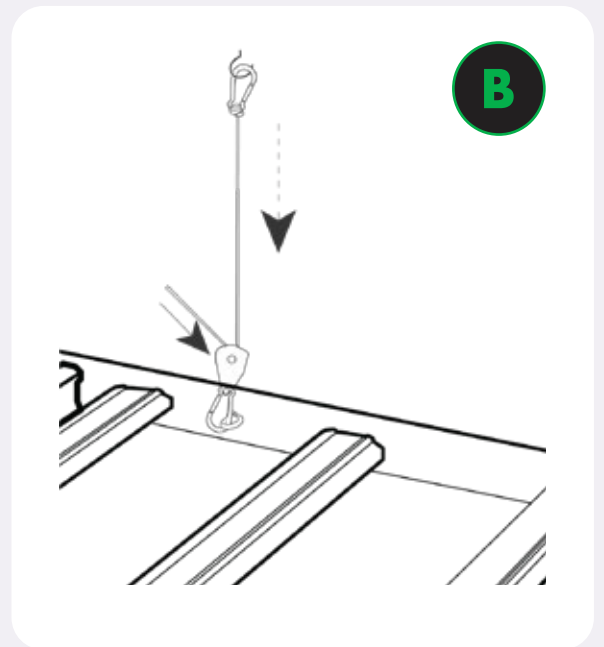

3. Once fixture is hanging with all LED bars installed, connect the power cable (blue tip) from the outlet to one side of the fixture.

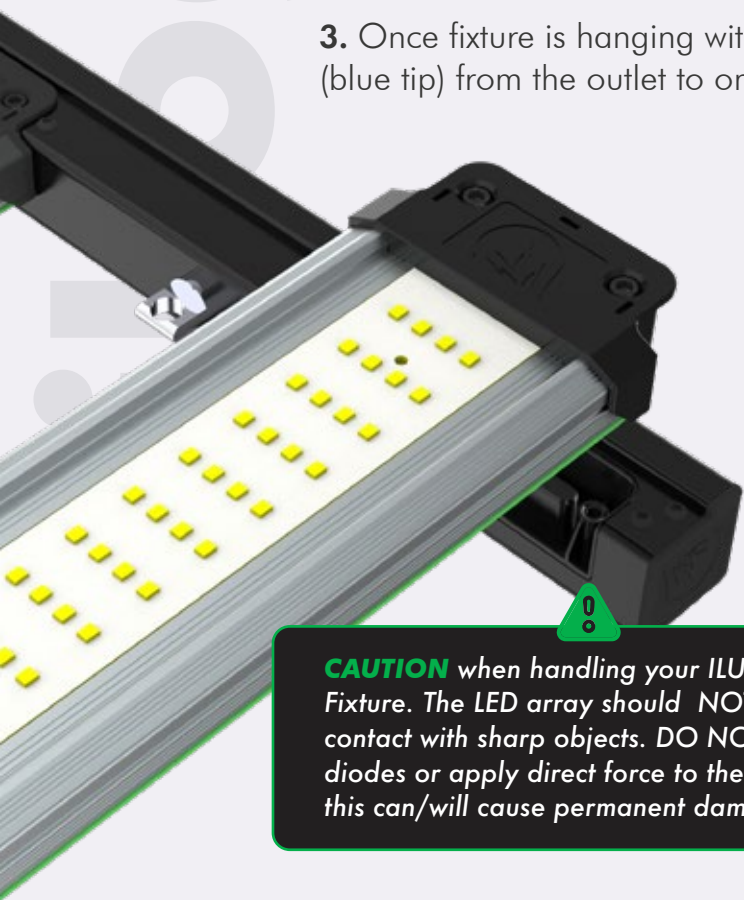

**CAUTION** when handling your ILUMINAR Fixture. The LED array should NOT come in contact with sharp objects. DO NOT touch diodes or apply direct force to the diodes as this can/will cause permanent damage.

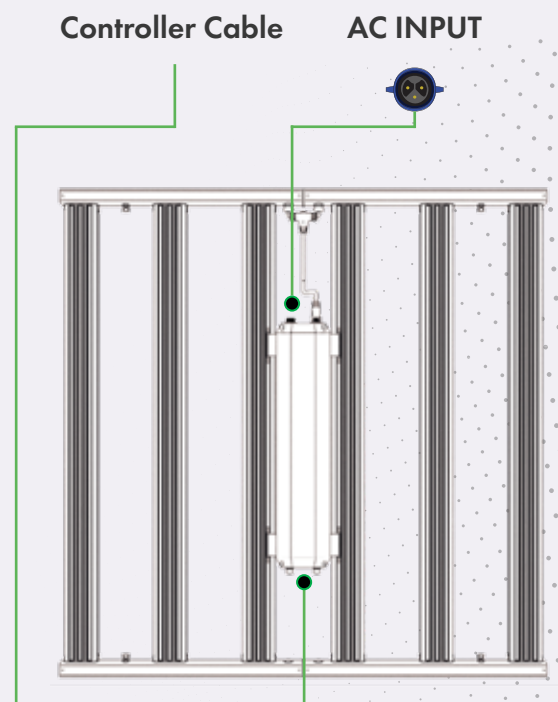



# BEFORE YOU BUY AN LED CHECK YOUR REBATE



**FIND OUT MORE**



[ILUMINARLIGHTING.COM](http://ILUMINARLIGHTING.COM)

# 07

## Important Cautions & Warranty



### PREPARATION

#### Transportation

Improper transportation may harm or can even cause damage to LED lamp and power housing box). In case of obvious damage or incomplete scope of supply, please refer to your vendor immediately.

#### Unboxing

Please handle and unbox the LED lamp with care! Check the delivery contents for completeness first. A detailed list of the product range is contained on the inner cover in this manual.



### OPERATION

#### Safety measures & precaution

**Warning!** This LED fixture is powered with electricity (**AC110-277V**)! To prevent injury, we ask you to desist from improper use!

Never open the case of the device! Health hazards await the consumer and the warranty of the device expires.

#### Putting into service

Operate the LED fixture only horizontally, while hanging or slightly angled (approx. about 20°). Deploy the LED lamp fixture about 30-60cm above the top of the plants.

#### Proper use

Do not use the LED fixture vertically or as illumination device upside-down (direct eye contact and long exposure over time may cause permanent damage to your eyesight!). We don't advise you to deploy the device as a room illuminate. It is exclusively designed and developed for plant breeding and cultivation. Please ensure that the LED fixture is being operated out of sight and out of reach of children and animals to protect their eyes!

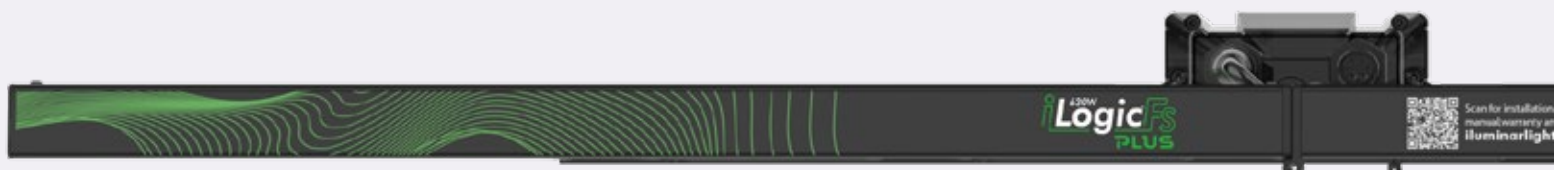

# 07

## Important Cautions & Warranty

### CAUTION

Please read the following list carefully prior to beginning installation.

- 1.** Leave at least one inch of space between the fixture and the mounting area for maximum performance and lifespan.
- 2.** ALWAYS wear protective eye wear when looking directly at the diodes to prevent eye damage.
- 3.** Only handle, clean or move fixture when it's unplugged and completely cool.
- 4.** Keep the fixture free of dust, debris, deposits to ensure the maximum potential of the fixture.
- 5.** NEVER use cloth to clean the diodes. This will scratch the diodes and could potentially break or dislodge them.
- 6.** DO NOT use chemicals to clean the fixture. Use ONLY low pressure air or low pressure water to remove dust and debris.
- 7.** Do NOT exceed 80% max load for breakers due to Inrush current in LED fixtures.
- 8.** Do NOT use sulfur vaporizers.

### GUARANTEE

**5 YEAR**  
WARRANTY

At ILUMINAR, we stand behind our products and our technology as well as our customers. All ILUMINAR LED fixtures are backed by our 5-Year Guarantee. Please visit our website [iluminarlighting.com/warranty](http://iluminarlighting.com/warranty) for more information.



